

CONNECTION PROFILES AND ACCESSORIES FOR MULTIWALL SHEETS

MULTIWALL 

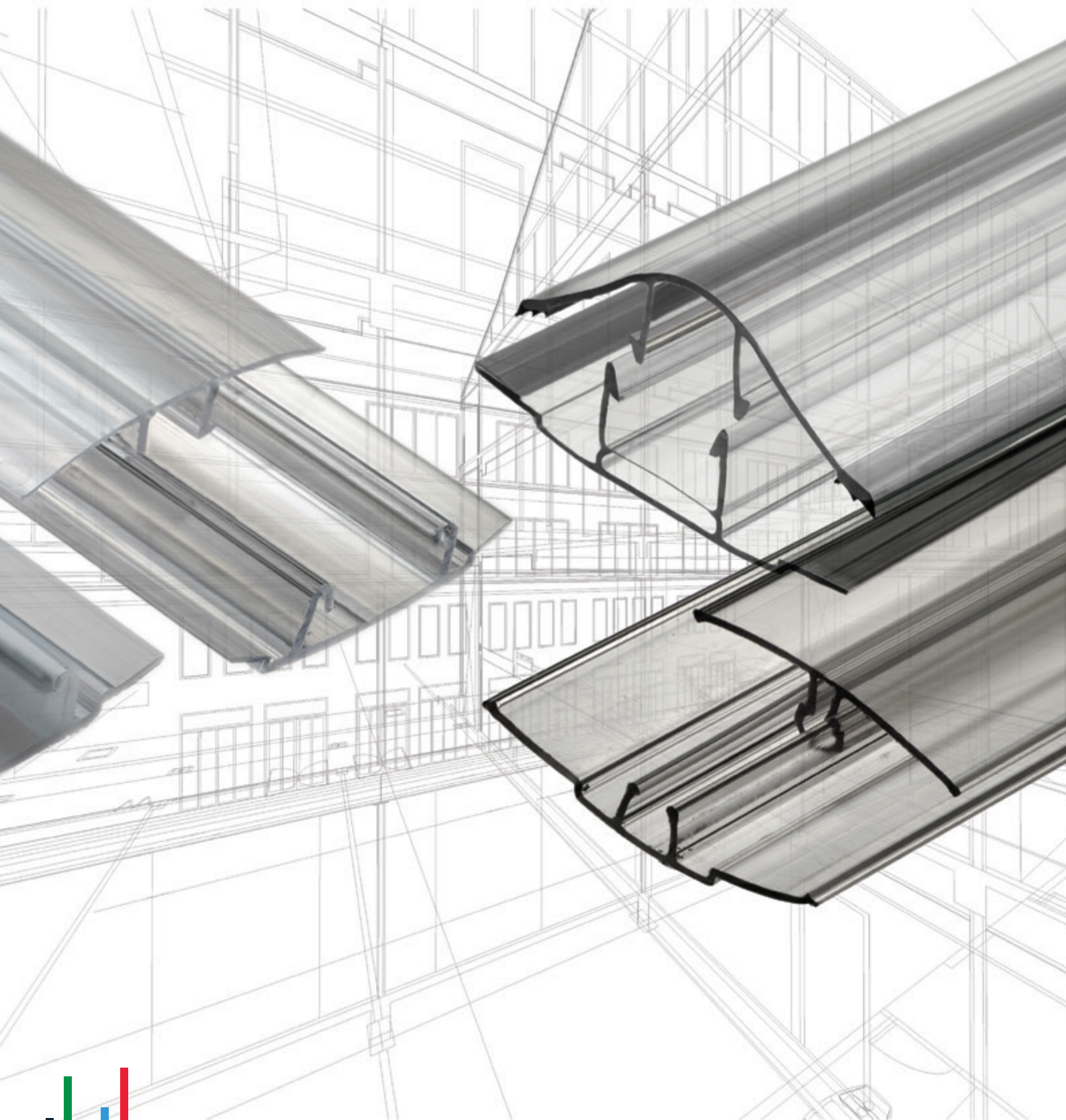



PLAZIT-POLYGAL CONNECTION PROFILES

DESCRIPTION

Plazit-Polygal interconnecting polycarbonate and/or aluminum profiles for PC multiwall sheets and systems are available in unlimited lengths, easy to handle, install and suit most type of roofing and cladding applications.

PROPERTIES

Profiles usually supplies in standard 6-meter lengths and has following advantages:

- Flexible and easy to use
- Light weight
- Unbreakable
- UV blocking layer
- Daylight transmission
- Environmentally friendly
- Easily be connected together to form reliable joints
- Wide range using for architectural projects
- Manufactured in all standard colors

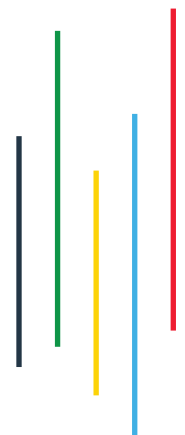



RECOMMENDED POLYCARBONATE CONNECTION PROFILES

Easy Clip (ECP) connection profiles are for use with sheets having a thickness from 6 to 10 mm and can be used in a wide variety of DIY, simple architectural and agricultural applications.



The profiles have a special "snap-and-click" design which does not require support of the base profile from below when installing, making them especially suitable for high roof installations.

The system includes screws for fixing the base profile to the support structure.

# 232 PC Cap Profile (All thicknesses)	# 233 PC Base Profile (for 6 mm)	# 234 PC Base Profile (for 8 and 10 mm)
		

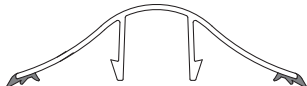
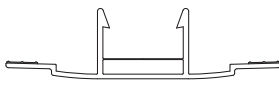

GCP (Gasket Clip Profiles) connection profiles with integrated gaskets are intended for use with sheets having a thickness from 6 to 10 mm sheets and are designed for greater water sealing capability. This system can be used in a wide variety of DIY, simple glazing and agricultural applications. The profiles have a "snap-and-click" design for connecting of base and cap profiles.

The system is available with both polycarbonate or aluminum base profiles and includes screws for fixing the base profile to the support structure.



# 251 PC Cap Profile (for 6, 8 and 10 mm)	# 252 PC Base Profile (All thicknesses)	# 331 Aluminum Base Profile* (All thicknesses)
		

* With EPDM Glazing Gaskets (#524)

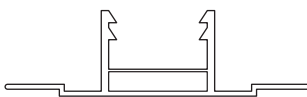
HCP connection profiles are intended for use with sheets having a thickness from 6 to 16 mm and can be used in a wide variety of DIY and agricultural applications. The profiles have a "snap-and-click" design for connecting of base and cap profiles. The system includes screws for fixing the base profile to the structure.



HCP Cap Profile (for 8 and 10 mm)	HCP Cap Profile (for 16 mm)	HCP Base Profile (All thicknesses)
		

HP Connection profiles are intended for sheets with a thickness 4 to 16 mm sheets and designed for a simple connection of sheets in DIY applications.

HP Cap Profile (for 4 and 8 mm)	HP Cap Profile (for 10 and 16 mm)
	

RECOMMENDED ALUMINUM GLAZING SYSTEM

Mega Lock (MGL) glazing system is specially designed for use in glazing with 8 to 16 mm polycarbonate multi wall sheets. The system has a rabbet depth of 20 mm, which enhances its fastening properties and prevents glazing failures due to wind and snow loads or thermal expansion. The profiles are interconnected by means of self-drilling screws of different lengths. The system includes screws for fixing the base profile to the support structure.

# 352 AL Cap Profile*	# 353 Base Aluminum	# 308 Aluminum Cover
		

FINISHING ACCESSORIES

- Aluminum Edge Profiles for trimming the sheets upper and lower edges
- Polycarbonate Edge Profiles for trimming the sheets upper and lower edges
- Screw for connection of MWPC sheet to supporting structure
- EPDM dome gasket and metal washer for sealing and fastening
- Anti-Dust tape for sealing the top and bottom edges of multiwall polycarbonate
- Sealant materials for sealing

Important guidelines

Various sealants or materials, including silicones, flexible seals, screw washers and all materials, which intended for contact with the polycarbonate profiles, should always be tested by Plazit-Polygal Lab.

DISCLAIMER: The data in this advertisement are provided in good faith and constitute general information without commitment and no warranty is given or implied. Our plastics products are a combustible thermoplastic that complies with various international standards, as customary in each country. Avoid exposure to excessive heat or aromatic cleaning solvent. Normal fire precautions should be taken to protect against combustion.

Plazit Polygal Group

info@plazit-polygal.com | Tel: +972.4.662.8888 | www.plazit-polygal.com

